

| Whitepaper.

Contents

Terminology	3
Abstract	4
1. Introduction	6
2. Vision	6
3. Overview	7
3.1. Current Problems of Existing Blockchain Networks	9
3.1.1. Trilemma	9
3.1.2. Transaction Speed	9
3.1.3. User Experience	9
3.1.4. Software Development	10
3.1.5. Decentralization	10
3.2. Metatime Solution	10
4. MetaChain	11
4.1. An Overview for MetaChain	13
4.2. MetaAnthill	14
4.3. EVM to MVM	16
4.4. MetaChain Consensus Mechanism: PoM	17
4.5. Transaction Check Per Second (TCPS)	18
5. Proof of Meta Consensus Mechanism	19
5.1. MetaMiner (MPoS & MetaAnthill)	21
5.1.1. Fees and Rewards	21
5.2. MacroMiner (MPoH & MetaAnthill)	22
5.2.1. Archive Node	23
5.2.2. Full Node	25
5.2.3. Light Node	27
5.3. MicroMiner (MPoSW & MetaAnthill)	29
6. Scalability	31
6.1. Blockchain Network Structure	33
6.2. Energy Consumption	33
7. Smart Contract	34
7.1. Smart Contract Compatibility	35
7.2. Smart Contract Fees	36

8. Transaction	37
8.1. Transaction Fees	39
9. Attack Vectors & Security	40
9.1. Transaction Denial	41
9.2. Eclipse Attack	42
9.3. Double Spending	43
10. Native Token	44
10.1. MetaCoin (MTC)	45
10.2. Token Burning	45
10.2.1. Transaction Fee Burning	45
10.2.2. Constant Burning	47
10.3. Pool Distribution	47
11. Experimental Results	48
12. Information	50
13. Audit	52
Solution and Conclusion	54
Focused on 'Human'	56
References	57
Disclaimer	59

Terminology

APR: Annual Percentage Rate.

Block Time: It is the time of block formation.

EVM: Ethereum Virtual Machine, a virtual machine that is present on all nodes. The EVM is a technology that ensures the proper and synchronous progress of all in-network developments and activities.

Layer-2: Layer-2 is a network structure that aims to find solutions by making structural changes to the main network structure.

MacroMiner: These are miners that operate with the MPoH consensus mechanism.

MASC: Smart contract formation is provided with an easy interface without requiring any technical knowledge in the ecosystem.

MetaAnthill: Intelligent, platform-independent and unique MetaChain solution that provides cross-node synchronization between nodes and hardware usage optimization in hybrid mining system.

MetaMiner: These are miners that operate with the MPoS consensus mechanism.

MicroMiner: These are mobile miners that operate with the MPoS consensus mechanism.

MPoS: Meta Proof of Stake or Delegated Proof of Stake by Metatime is a consensus mechanism that is similar to the PoS (Proof of Stake) system in terms of its features, but works faster and fairer than the PoS algorithm.

MPoH: Meta Proof of History is a mechanism developed by Metatime, that tries to prove in what order the transactions taking place on the blockchain are and whether the transactions are proceeding correctly. Meta Proof of History ensures the fast operation of the network while maintaining the security of the blockchain network.

MPoS: Meta Proof of Social Work developed by Metatime, checks the transactions reaching the blockchain and ensures that they are confirmed or denied quickly, as well as providing guidance to the user to answer questions about the ecosystem and contributing to the ecosystem in a social sense.

MTC: MetaCoin is the native token of the MetaChain network.

Node: Node is the name given to devices that have many functions such as forming the consensus mechanism of a blockchain network, ensuring the security of in-network activities, and storing data.

PoM: Proof of Meta, or Hybrid consensus mechanism, is a unique MetaChain solution that incorporates MetaAnthill technology and MPoS, MPoH and MPoS consensus mechanisms.

TCPS: Transaction Check Per Second is the number of transactions that can be verified and confirmed per second.

TCP: It is a protocol that provides data transmission between devices.

TCT: It is Transaction Check Time.

TPS: Transaction Per Second is the number of transactions where a blockchain network can process the transactions per second.

TxPool: An organized sequence in which transactions are stored and sorted before being added to a new block.

Abstract

The principles of data storage, processing, ownership and transparency of blockchain technology in relation to them have led developers to develop decentralized applications at an increasing rate day by day. With the increasing demand for these developed applications and technology, existing solutions have faced **scalability, speed and security** problems. Besides, the focus of the solutions has been given priority to narrow user groups familiar with technology instead of the wider audience. In order to enable the mass acceptance and widespread use of the Web 3.0 era, blockchain infrastructures need to be scalable, cost-effective, and continuously improved structures similar to cloud solutions, as well as their reliability. In this way, the development of applications that are used by the wider audience can be advanced.

MetaChain is a blockchain network that prioritizes scalability, speed, security and decentralization in order to eliminate the aforementioned problems. The network allows large audiences to access blockchain technology with human-centered interaction surfaces, and is built on the EVM (Ethereum Virtual Machine) architecture.

MetaChain has been in development since 2019 by Metatime. MetaAnthill Technology, which focuses on the "human" factor and is named after the organized working capacity of ants includes original and innovative solutions such as the Hybrid Mining system within the Proof of Meta concept. This combination of innovative technologies and models aims to eliminate the fundamental problems that hinder the widespread adoption of Web 3.0.

- MetaChain benefits from MetaAnthill technology to enable fast and secure transactions. MetaAnthill acts as a software library written in Java, a platform-independent integrated accelerator and a smart processing router that works accordingly.
- Proof of Meta hybrid consensus mechanism sends all transactions to MetaMiner, MacroMiner and MicroMiners, which are part of the hybrid mining system. By the help of smart load optimization, hundreds of thousands of transactions can be audited and processed simultaneously. The verified transactions, if confirmed, are shared on the network by processing into the blocks and synchronized by all nodes.
- The unique hybrid mining system allows the human factor to directly contribute to and drive the ecosystem. In this context, 3 mining options are offered with different roles called MetaMiner, MacroMiner and MicroMiner, and each of these options has decision-making mechanisms that contribute to the ecosystem.
- MetaChain is the ground component of an entire ecosystem in which basic applications work integrated with each other and forms the infrastructure of the ecosystem.
- The main solutions developed by Metatime will form parts of the ecosystem on the first day the blockchain network is launched and will have its own ecosystem in MetaChain.

| 1. Introduction

Metatime is a main company of its ecosystem, whose main product is the MetaChain blockchain and all the applications built and designed on this chain. Metatime presents a blockchain-based technology that has been in development since 2019 to the end users. With algorithms and culture based on justice and a blockchain ecosystem that can affect people's daily lives and enables, that anyone can benefit from the advantages of this technology.

| 2. Vision

The focus of Metatime's scope of vision is to expand the existing blockchain solutions. Metatime has designed a complete ecosystem based on blockchain technology to make a difference in people's daily lives, through **integrated native applications** that we developed and are developing on MetaChain.

Thanks to this integrated ecosystem, of which MetaChain is the foundation, many transactions existing in the real world and Web 2.0 based structures, can be built on blockchain technology.

Human-focused transactions can be performed in a much more cost-effective, easy and secure way in the Web 3.0 world. With the versatility of integrated applications, running on MetaChain.

| Overview

Metatime is not just a blockchain ecosystem,
it is also a culture.

3. Overview

Before starting the development of MetaChain and the ecosystem built on it, the Metatime planned and designed, proactively identified future user needs, and gathered all the necessary technological knowledge and infrastructure.

End-to-end solutions from the daily needs of individuals to the most complex problems of corporate structures; **Metatime offers a fast, secure and scalable ecosystem by combining blockchain technology-based products in a decentralized and integrated manner.**

MetaChain, has been designed considering all scenarios where applications to work on, integrations to be made by developers and the usage rates of blockchain technology increase.

Metatime is not just a blockchain ecosystem, it is also a culture.

Our main goal is to create a unique culture with MetaChain native applications. To lead the completion of the **human-centered evolution of blockchain technology** by applying the guidance of the end-user at all stages where the culture and ecosystem are shaped.

3.1. Current Problems of Existing Blockchain Networks

3.1.1. Trilemma

Blockchain networks mostly concentrate on certain areas within the structural form, commonly called the trilemma triangle. These areas, including speed, scalability and security, represent the corner points of the Trilemma. Since this situation causes project-based problems for blockchain application developers, there is a need for other structures integrated into networks and as a result, Layer-2, Side-chain, ZK-rollup and similar solutions are expected to be developed by different teams.

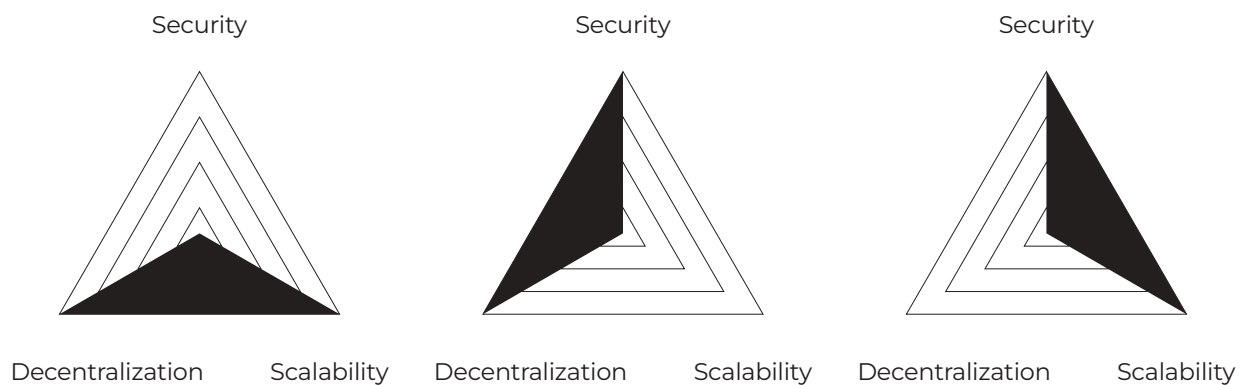

Blockchain networks that are experiencing trilemma problems may show weakness from time to time. The abovementioned Layer-2 solutions built on top of the network by different developers, and end-users may experience loss of time and loss of effort and financial losses due to these problems.

3.1.2. Transaction Speed

Existing blockchain networks are not yet in a position to respond adequately and effectively to today's needs. Transaction fees are high and transaction speed is insufficient in chains operating with existing consensus mechanisms.

3.1.3. User Experience

Many topics such as chain transactions, trading, wallet creating, wallet connecting, swapping, CEX (Centralized Exchange)-DEX (Decentralized Exchange) preference, password storage involve complex processes regarding the average user.

3.1.4. Software Development

Chains that do not offer EVM and Solidity support present a barrier to entry, by using different technologies to provide high processing speed. This leads to a challenging learning curve for software developers. In particular, even if they offer functional infrastructures within themselves.

3.1.5. Decentralization

Chains using PoS and DPoS consensus mechanisms, even if they offer energy efficiency, speed and low fees, the structure they create is closer to being centralized and constitute groups within themselves.

3.2. Metatime Solution

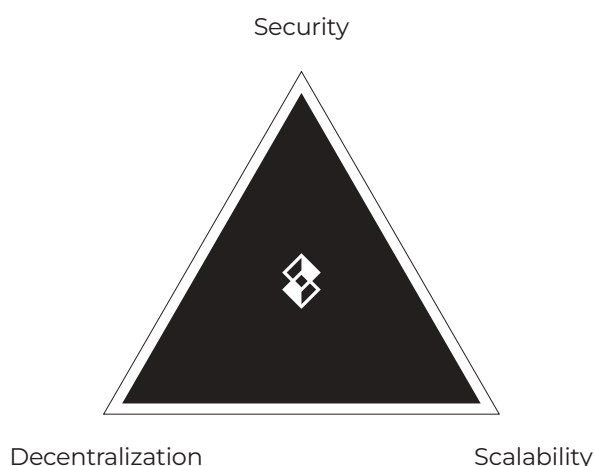

Metatime has managed to reach the main source of the problem by redesigning the related setup and to minimize this problem by creating user scenarios that provide optimum efficiency in the trilemma triangle.

The ecosystem has been evaluated as platform-independent on the axis of technology and a hybrid mining system has been created by building the most efficient structures on top of the used hardware. Directly connected to the human factor, and parts of the ecosystem are designed to work integrated with the mining system.

MetaChain

Secure, fast and supported with EVM

4. MetaChain

MetaChain is a blockchain network that has brought a hybrid mining system solution under the management of platform-independent mining control technology MetaAnthill, with the support of Proof of Meta consensus mechanism to the deficiencies and improvement points of the blockchain infrastructure.

By optimally meeting the demands of individuals and institutions for systems with speed, security and scalability problems, it brings together all the pieces of the puzzle on a single network and offers blockchain-based integrated solutions in a single decentralized ecosystem, without the need for any Layer-2 solution.

Scaling → MetaAnthill

MetaAnthill technology allows users to take full advantage of the speed of the Web 3.0.

Security → Hybrid Mining

It provides maximum security by increasing the blockchain structure to the maximum level of distribution with MetaMiner, MacroMiner and MicroMiners located in hundreds of thousands of different locations.

Decentralization → PoM Consensus

Unlike other consensus mechanisms, PoM (Proof of Meta) connects the solution of the blockchain trilemma to the participation and the guidance of all users, and its focus is on decentralization, thanks to its hybrid nature.

4.1. An Overview for MetaChain

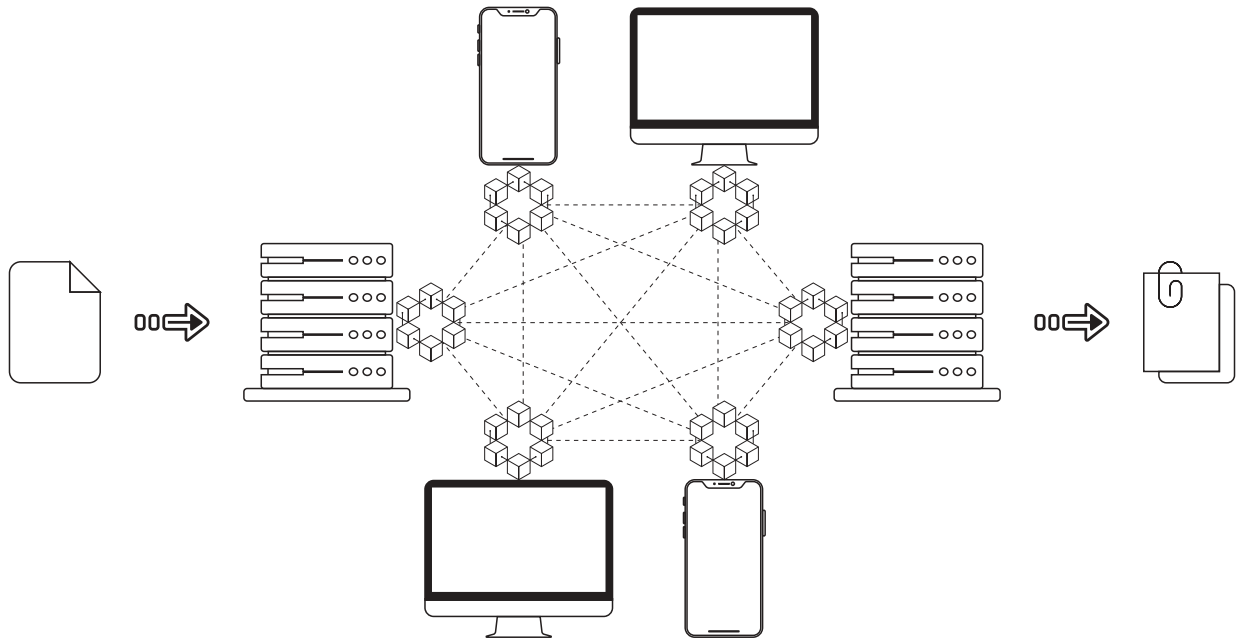

The advantage of device diversity is provided so that maximum performance can be obtained from all devices, from servers, computers and mobile devices, thanks to the multi-platform supported developments.

The transaction is detected and pre-verified in MetaAnthill on the relevant node, as soon as a transaction request comes to the network. Once the transaction is confirmed, synchronization between nodes is ensured by building a consensus according to the transaction type.

Thanks to this unique structure of MetaChain, it is possible to verify and confirm transactions in milliseconds.

4.2. MetaAnthill

MetaAnthill technology has been developed in order for the hybrid mining system in MetaChain to synchronize at high speed and use the resources of the platform-independent hardware in the most efficient way.

Inspired by nature, MetaAnthill literally means ant-hill. The working method of ants, which are able to instinctively realize the most advanced and optimal scenarios. In terms of workforce allocation and efficiency, has been adopted and the structure of the anthill has been internalized in terms of the created work path.

MetaAnthill acts as a software library written in Java. It acts as a platform-independent integrated accelerator and a smart processing router that works accordingly. MetaAnthill, which scans the device it is on at the hardware level and acts according to the configuration and available resources of the hardware, also creates the path structure of the network for synchronization between nodes.

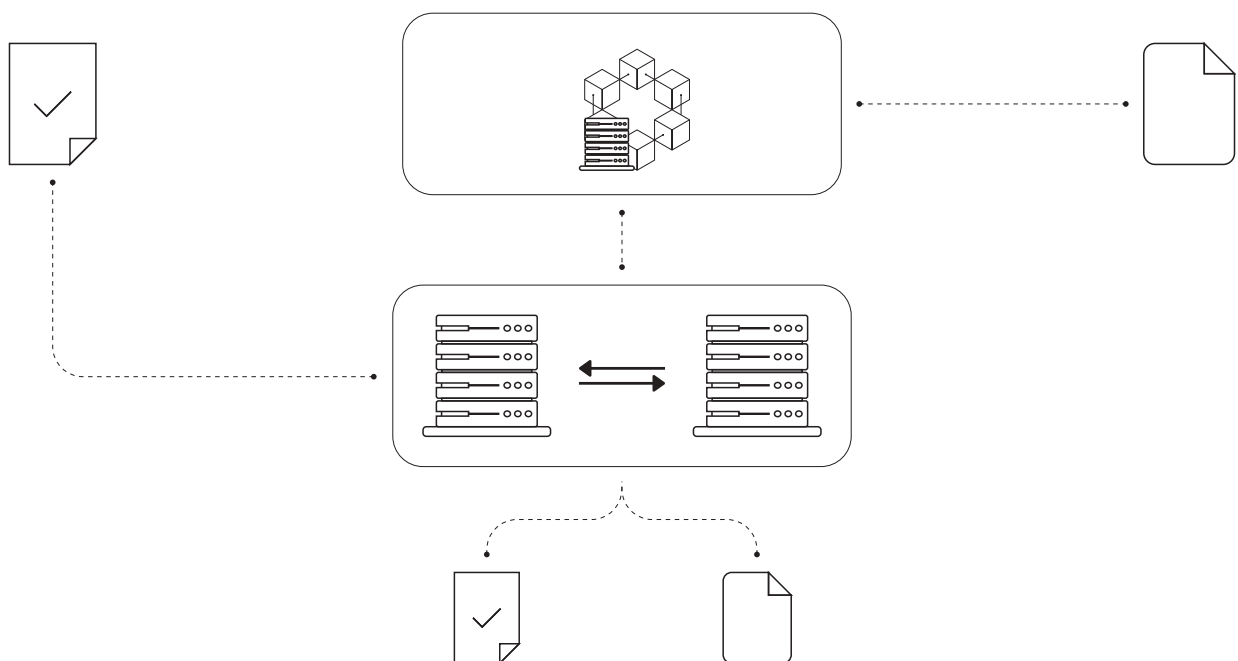

MetaAnthill, which allows the blockchain network to be more scalable. It minimizes confirmation times of transactions, meets millions of transactions instantly on MetaChain. It provides pre-verification and confirmation of them as a result of seamless inter-node synchronization.

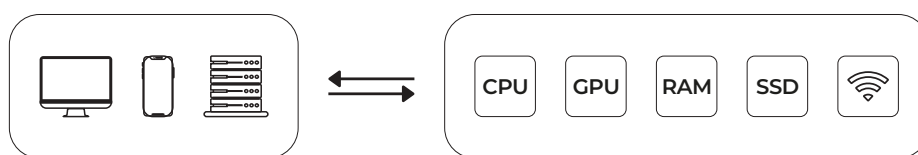

PC Phone Smart Contract Transaction Server MetaAnthill

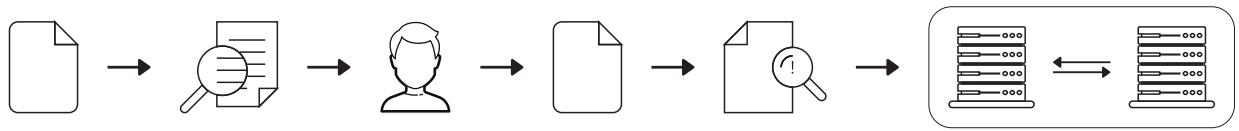

MetaAnthill also performs different tasks. Depending on the role and node type of the miners that make up the system.

MetaMiner Provides monitoring of the entire traffic in the network and directing the traffic according to the incoming transactions.

MacroMiner ensures that the hardware required for MetaChain is analyzed, and the necessary software installations are completed and used.

MicroMiner monitors the density and ping time of the node, provides communication and directing for fast synchronization and integration of all transactions into the blockchain network in the shortest way.

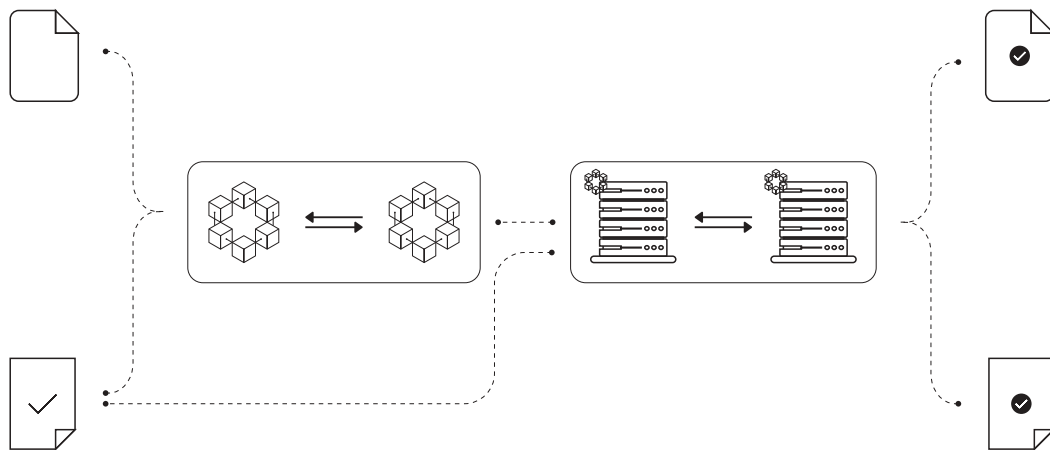

MetaAnthill divides incoming queries to the blockchain into transactions and more.

All incoming transactions in order to ensure the verification and confirmation of hundreds of thousands of transactions in the same second are pre-verified by MetaAnthill and sent to MetaMiner, MacroMiner and MicroMiners, which are part of the hybrid mining system, for block generation using smart load optimization. Verified transactions, if confirmed, are processed into blocks and shared with the entire network and synchronized by Meta and Macro nodes.

Incoming Smart Contracts, on the other hand, are transmitted directly to TxPool, without any waiting process, they take their place in the generated block and are synchronized.



4.3. EVM to MVM

The Ethereum Virtual Machine (EVM) is a global virtual machine. Contributed by thousands of developers, adopted by blockchain communities and actively used. Although it has proven itself in terms of operation and has a stable working structure. It remains below the desired efficiency, especially in terms of confirmation time of transactions, block generation time, transaction approval speed due to transaction queues and fees paid for transactions.

Ethereum Virtual Machine & Consensus

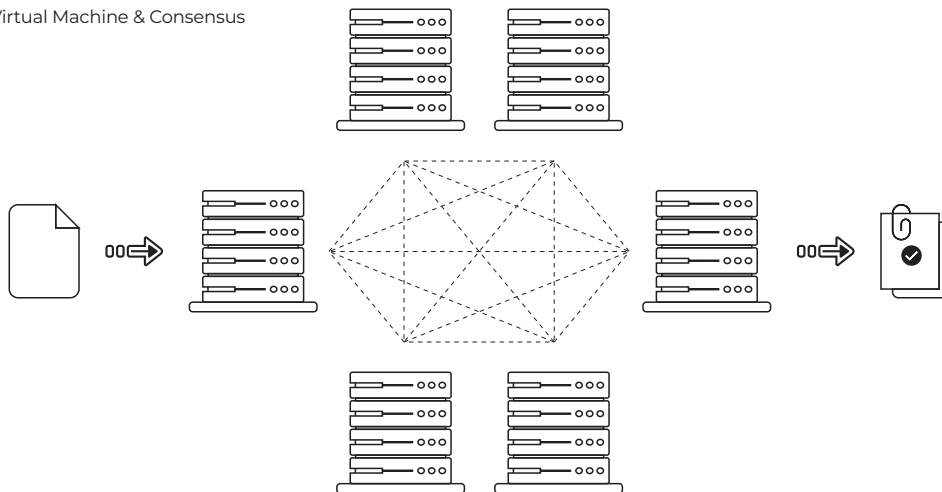

Meta Virtual Machine & Proof of Meta & Anthill

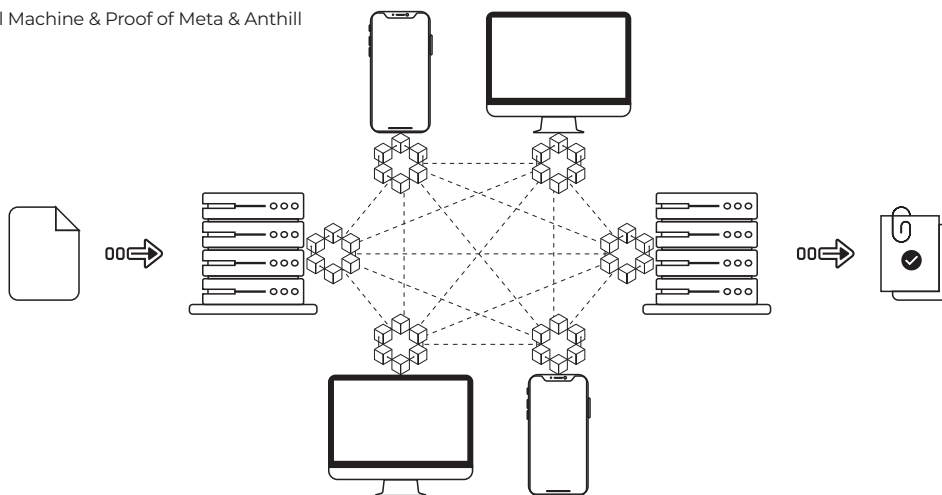

Meta Virtual Machine (MVM), on the other hand, enables fast transaction approval in addition to all the security and compliance provided by EVM. Also it enables fast transaction verification with its unique consensus structure and high-speed communication and synchronization capabilities between nodes.

This conceptual transformation, which is based on the importance given to developers and human-centered architecture, develops and carries forward the potential offered by EVM without creating any deficiencies by the end user.



4.4. MetaChain Consensus Mechanism: PoM

In the Proof of Meta consensus mechanism, all incoming data is queried **instantly**. Incoming smart contract transactions are sent directly to TxPool.

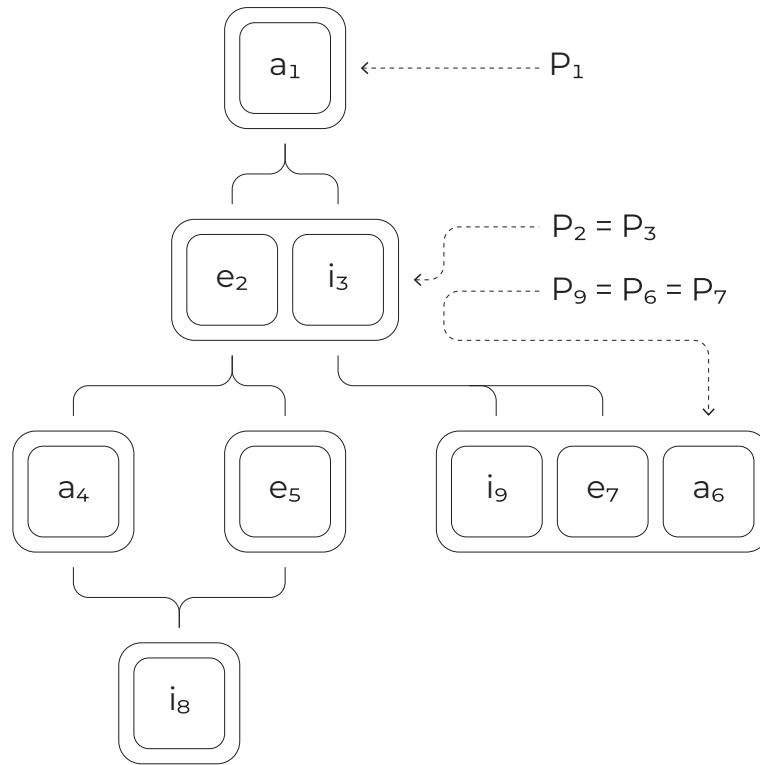

As shown in the picture, an instant pre-verified of incoming transactions is performed by verifying on the basis of 'a' 'e' 'i' via MacroMiner and MicroMiner without waiting for the completion of the block time.

$$\left. \begin{array}{l}
 \text{if } \left\{ \sum_{e=0}^1 (e_1 + e_2 + e_3 \dots + e_n) \right\} = \mathbb{1} \quad \sum e_n = \alpha \quad \checkmark \\
 \text{if } \left\{ \sum_{a=0}^1 (a_1 + a_2 + a_3 \dots + a_n) \right\} = \mathbb{1} \quad \sum a_n = \beta \quad \checkmark \\
 \text{if } \left\{ \sum_{i=0}^1 (i_1 + i_2 + i_3 \dots + i_n) \right\} = \mathbb{1} \quad \sum i_n = \Gamma \quad \checkmark \\
 \vdots \\
 \text{if } \{ \alpha + \beta + \Gamma \}
 \end{array} \right\}$$

4.5. Transaction Check Per Second (TCPS)

Most blockchain networks offer probabilistic transaction certainty. In other words, transactions do not become definite immediately, they finalize after a certain number of additional blocks are added to the chain. The main idea here is that as blocks continue to be confirmed and added, the probability that previous transactions will be valid and irreversible increases.

Although TPS measures speed, it may not correlate with certainty. A chain may have high TPS based on a reasonable definition of transactions, but may take longer to establish precision depending on TCPS and TPS.

Transaction Check Per Second (TCPS) is the number of transactions that can be pre-verified and denied in an instant.

MetaChain with a brand new approach — thanks to MetaMiner, MacroMiner, MicroMiner components and MetaAnthill technology, which form the consensus structure — optimally sustains the factors that other networks today have to waive with scaling solutions.

In the optimum hardware and network topology, the block time is less than 5 seconds and the node synchronization time is instantly.

In tests with 19 nodes, it was possible to verify and confirm more than 700,000 transactions per second. It is predicted that theoretically, as long as TCP (Transmission Control Protocol) support is provided, up to 3.3 million transactions per second can be reached.

Blockchain Networks	Transaction Pre-Verification Process	TCPS
MetaCoin (MTC)	Instantly	700,000 +
Bitcoin (BTC)	10 min	7
Ethereum (ETH)	15 sec	100,000
Solana (SOL)	0,4 sec	60,000
EOS (EOS)	0,5 sec	10,000
Stellar (XLM)	2 - 5 sec	10,000
Litecoin (LTC)	2,5 min	56
Avalanche (AVAX)	1 - 2 sec	6,500

Proof of Meta Consensus Mechanism

Hybrid Mining & MetaAnthill

5. Proof of Meta Consensus Mechanism

Although it seems that Ethereum's transition from PoW to PoS and the relatively new networks started directly as PoS have eliminated the need for miners. In fact, validators in PoS systems have undertaken the technical requirements such as providing and maintaining servers.

Implementation	Proof of Meta (PoM)	Proof of Work (PoW)	Proof of Stake (PoS)	Delegated Proof of Stake (dPoS)	Proof of Authority (PoA)
Accessibility	High	High	High	Low	Low
Decentralization	High	Yes	Partially	Partially	Low
Scalability	High	Low	High	High	High
Low Latency	Yes	No	Yes	Yes	Yes
Transparency	High	High	High	Partially	Low
Smart Contract	Yes	Limited	Yes	Yes	Yes
Security	High	High	Partially	Partially	Partially
Network Intensive	Partially	Yes	Partially	Partially	No

Metatime argues that mining needs to go beyond providing servers to users who are already on the blockchain network and take place at the focal point. In addition, it has been determined that since mining requires technical knowledge that only experts can have, it cannot create sufficient resources to direct the future of blockchain technologies and meet the needs of the end user.

For this reason, **the hybrid mining system Proof of Meta (PoM)**, exclusive to MetaChain, allows people to directly contribute to the whole ecosystem and lead the ecosystem in both technical and social context, as well as systems that work directly integrated with the network the mining system offers 3 different options, each with its own decision-making mechanisms that contribute to the ecosystem.

5.1. MetaMiner (MPoS & MetaAnthill)

MetaMiner undertakes the Signer task, which creates the unchangeable structure of the blocks, in addition to the task of confirming and archiving the transactions in the incoming block in the formation of the chain structure of the network.

The user who wants to take the task of MetaMiner, the highest level stakeholder of Hybrid Mining, stakes a specified number of MTCs and makes the MTC payment in return for the annual rental amount. Then, a ready-to-use node is provided to the user by Metatime and the user who undertakes the task of MetaMiner has full control over the node. The server can be managed through the administration panel and can be disabled at any time to terminate the service.

5.1.1. Fees and Rewards

The MTC amount and mining reward that users who want to become MetaMiner must pay on an annual basis are as follows:

1.000.000 MTC stake + 100.000 MTC annual server rental fee.

The daily MTC reward that MetaMiner included in the system will receive from the Reward Pool is calculated by the formula:

$$\frac{(166.666)}{\text{Total MetaMiner}}$$

A MetaMiner's maximum daily MTC reward is 450 MTC.

5.2. MacroMiner (MPoH & MetaAnthill)

MacroMiners are miners who undertake the task of expanding the decentralized and distributed structure of MetaChain, performing signature verification and back up the blockchain, and meeting the hardware needs for integrated ecosystem applications.

Desktop application for MacroMiner is designed in a structure where everyone can easily contribute to the ecosystem and perform mining operations. Through its easy installation, multi-operating system support and minimum hardware requirement.

Users who want to become MacroMiner can easily determine the minimum hardware needed on the screen that appears after downloading the software compatible with their operating system from "<https://download.metatime.com>". The user who logs in with their wallet only needs to ensure that the hardware remains uninterrupted at the beginning of the process.

In reward distribution, there is a policy of high reward in exchange for loyalty and stability. MacroMiners are divided into 3 groups, according to the hardware power they will provide to the PoM consensus mechanism.

5.2.1. Archive Node

The minimum hardware power requirements that users who want to undertake the task of **Archive Node** must provide:

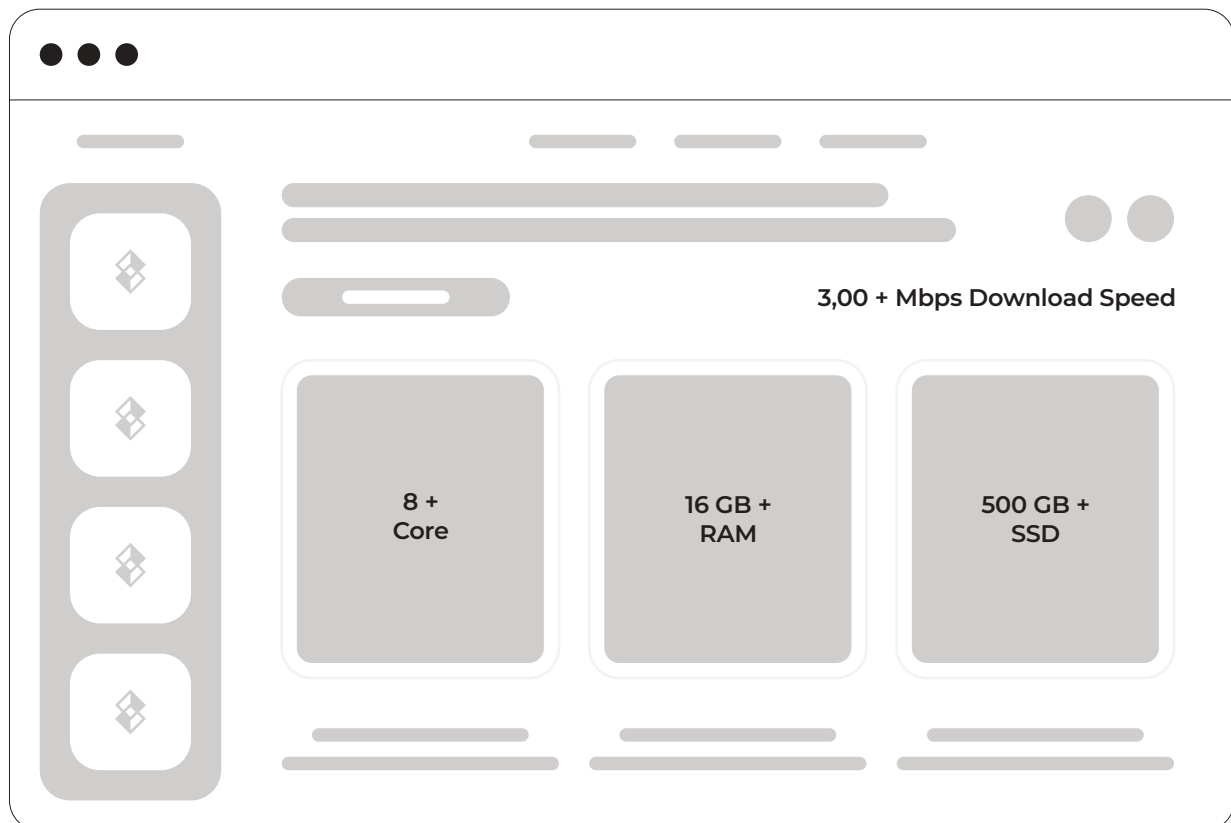

From the moment Archive Node joins the system, its reward is calculated with multiple parameters. Every day at 00:00 (UTC), Archive Node receives its reward from the total miner pool, which is 75.000 MTC and renewed daily.

Archive Node can track its share of the reward from the miner pool, which is updated hourly, but can only be transferred to its wallet at 00:00 (UTC). An Archive Node can earn a maximum of 150 MTC in a 24-hour period.

The MTC amount that will be added to an Archive Node's balance for each hour it provides hardware power is calculated using the following formula:

$$\frac{60.000}{24 \times TN}$$

(TN: Total Node)

In addition to the MTC reward earned from the 60.000 MTC reward pool, an Archive Node earns "1MP" for providing uninterrupted hardware power for each 24-hour period. The earned MP points are permanently added to the point balance. At 00:00 (UTC), the Archive Node receives the uninterrupted service reward from the 15.000 MTC mining pool proportional to its MP balance and the number of hours it was active during the day.

The MetaCoin reward earned at the end of the day is calculated by the following formula:

$$\frac{15.000}{\text{TMP} \times \frac{\text{TA}}{\text{TN} \times 24}} \times \text{MP} \times \frac{\text{A}}{24}$$

(MP: Meta Points)

(TMP: Total Meta Points in the pool)

(TA: Total active hours of all Archive Nodes for the reward day)

(TN: Total Nodes)

(A: Active hours during the day)

(1MP ≡ 1)

For instance;

If there are 50.000 active Archive Nodes during the balance update time, the mining reward for that hour will be 0,05 MTC, calculated as $60.000 / (50.000 \times 24)$.

Assuming the user's MP balance is 10, the total MP in the pool (TMP) is 300.000 and the total active hours (TA) is 250.000, a 24-hour active Archive Node will be eligible for a reward of:

$$\frac{15.000}{300.000 \times \frac{250.000}{50.000 \times 24}} \times 10 \times \frac{24}{24} = 2,4 \text{ MTC}$$

and a total of 3.6 MTC can be withdrawn to the wallet at 00:00 (UTC).

The calculated reward in MTC is hypothetical. The number of nodes in the pool, active hours, and MP owned can increase or decrease based on circumstances.

5.2.2. Full Node

The minimum hardware requirements that users who want to undertake the task of **Full Node** must provide:

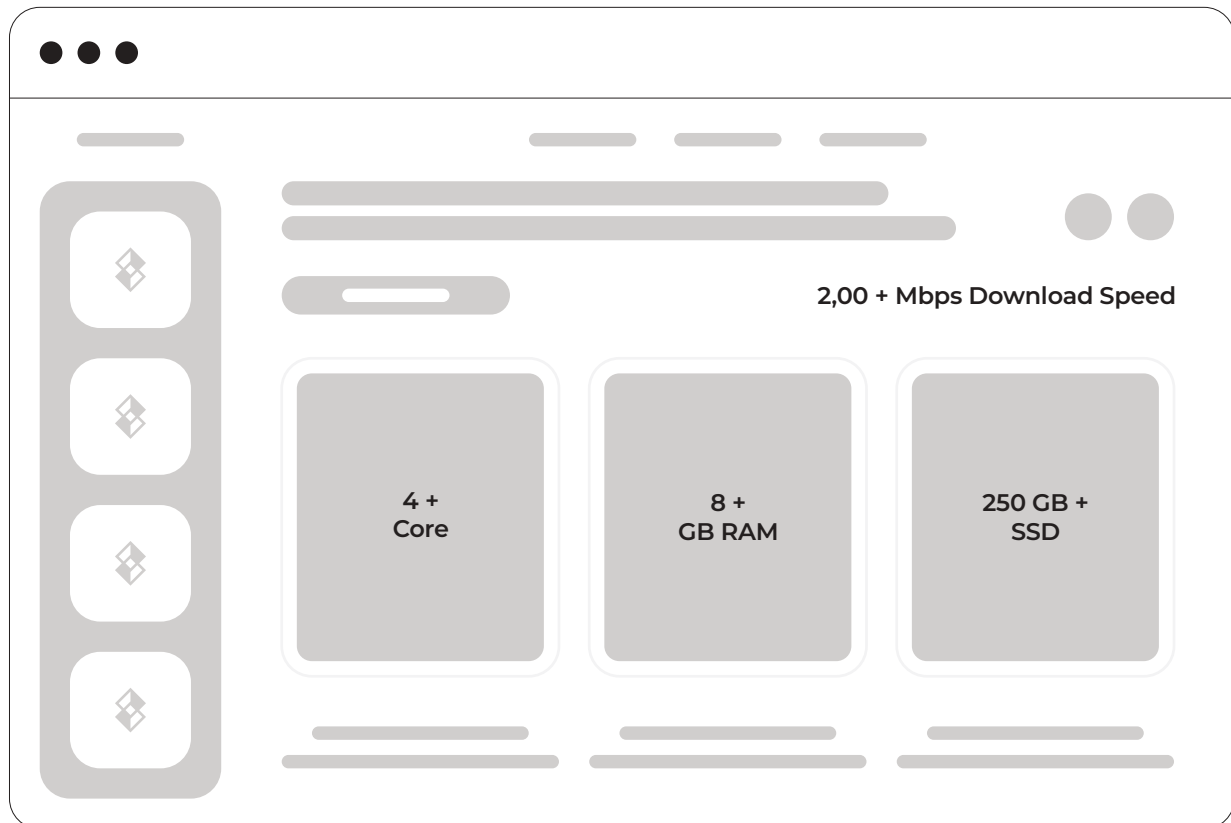

Starting from the moment it joins the Full Node system, the reward of the Full Node is calculated based on multiple parameters, just like the Archive Node, and it receives its reward from a total of 50.000 MTC miner pool that is renewed every day at 00:00 (UTC).

The Full Node can track its share of the reward from the miner pool updated hourly, but it can transfer it to its wallet only at 00:00 (UTC). A Full Node can earn a maximum of 100 MTC within a 24-hour period.

The amount of MTC that will be reflected in a Full Node's balance for each hour of hardware contribution is calculated according to the following formula:

$$\frac{40.000}{24 \times TN}$$

(TN: Total Node)

In addition to the MTC reward earned from the 40.000 MTC reward pool, a Full Node earns "1MP" for every uninterrupted 24-hour period of hardware contribution. The earned MP is permanently added to the point balance. At 00:00 (UTC), the Full Node can receive the uninterrupted service reward from a 10,000 MTC miner pool in proportion to the MP balance and the number of active hours during the day.

The MetaCoin reward that can be earned based on the MP accumulated by the end of the day is calculated according to the following formula:

$$\frac{10.000}{\text{TMP} \times \frac{\text{TA}}{\text{TN} \times 24}} \times \text{MP} \times \frac{\text{A}}{24}$$

(MP: Meta Point)

(TMP: Total Meta Point in the pool)

(TA: Total active hours of all Archive Nodes on the reward day)

(A= Active Hours During the Day)

(1MP ≡ 1)

For instance;

If there are 25.000 active Full Nodes during the balance update time, the mining reward for that hour will be $40.000 / (25.000 \times 24) = 0,06666\dots$ MTC.

Assuming the user's MP balance is 5, the total MP in the pool (TMP) is 600.000 and the total active hours (TA) is 500.000, a Full Node active for 24 hours will be defined to be able to withdraw a total of 1,7 MTC at 00:00 (UTC), together with 0,1 MTC earned based on the formula above,

$$\frac{10.000}{600.000 \times \frac{500.000}{25.000 \times 24}} \times 5 \times \frac{24}{24} = 0,1 \text{ MTC}$$

The calculated reward amount in MTC is hypothetical and can vary depending on the number of nodes in the pool, the active hours, and the MP balance.

5.2.3. Light Node

The minimum hardware power requirements that users who want to undertake the task of **Light Node** must provide:

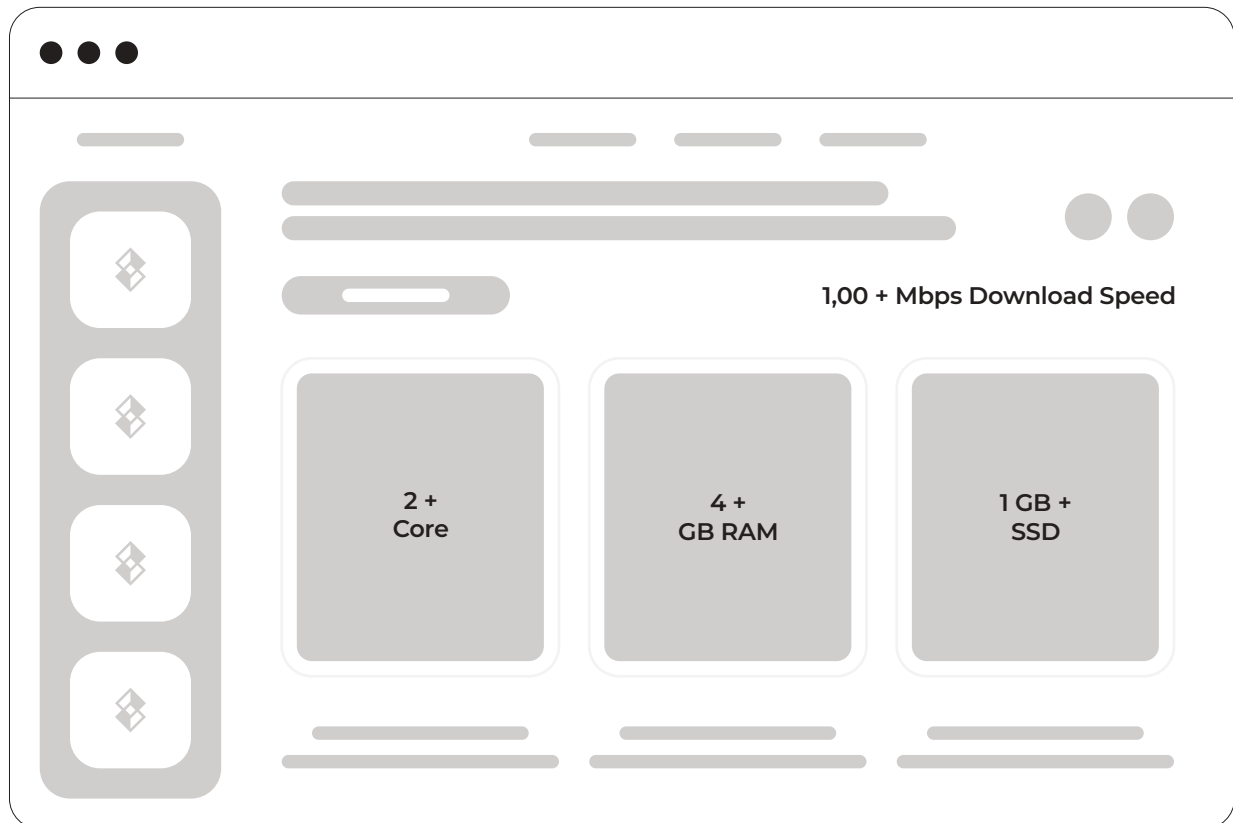

Starting from the moment it joins the Light Node system, its reward is calculated with multiple parameters just like Archive Node and Full Node, and it receives its share from the total 25.000 MTC miner pool, which is renewed at 00:00 (UTC) every day.

Light Node can track the reward it is entitled to from the miner pool with hourly updates, but can transfer it to its wallet at 00:00 (UTC). A Light Node can earn a maximum of 50 MTC within a 24-hour period.

The MTC amount reflected in the balance of an Archive Node for each hour of hardware provided is calculated according to the following formula:

$$\frac{20.000}{24 \times TN}$$

(TN: Total Node)

In addition to the MTC reward earned from the 20.000 MTC reward pool, a Light Node earns "1MP" for every uninterrupted 24-hour period of hardware it provides. The earned MP is permanently added to the point balance. At 00:00 (UTC), the Light Node receives its uninterrupted service reward from the 25.000 MTC mining pool in proportion to its MP balance and the number of active hours during the day.

The MetaCoin reward to be earned in exchange for the MP owned at the end of the day is calculated according to the following formula:

$$\frac{5.000}{\text{TMP} \times \frac{\text{TA}}{\text{TN} \times 24}} \times \text{MP} \times \frac{\text{A}}{24}$$

(MP: Meta Points)

(TMP: Total Meta Points in the pool)

(TA: Total active hours of all Archive Nodes on the reward day)

(A: Active hours during the day)

(1MP ≡ 1)

For instance;

If there are 71.000 active Light Nodes during the balance update time, the mining reward for that hour will be $20.000 / (71.000 \times 24) = 0,01173\dots$ MTC. Let's assume that the user's MP balance is 17.

If the total MP in the pool (TMP) is 195.000 and the total active hours are 300.000, a Light Node active for 24 hours will be defined to be able to withdraw a total of 2,76 MTC, including 2,48 MTC earned.

$$\frac{5.000}{195.000 \times \frac{300.000}{71.000 \times 24}} \times 17 \times \frac{24}{24} = 2,48 \text{ MTC}$$

The calculated reward amount in MTC is hypothetical and can increase or decrease depending on the number of nodes in the pool, the hours active, and the MP owned.

5.3. MicroMiner (MPoS & MetaAnthill)

MicroMiner, which is one of the most essential parts of the human-centered blockchain structure. It creates a direct link between the Metatime ecosystem applications and the user, beyond undertaking the transaction verification task systematically.

```
pragma solidity ^0.8.0;

import "@openzeppelin/contracts/utils/Strings.sol";
contract Vote {
    using Strings for uint256;
    address private immutable owner;
    string _baseUri;
    uint256 totalVote;
    struct Votes {
        uint256 startTime;
        uint256 endTime;
        uint256 selection;
        string question;
        mapping (uint256 => uint256) selections;
        mapping (address => uint256) voter;
    }
    mapping (uint256 => Votes) _votes;

    constructor(string memory base_Uri_) {
        owner = msg.sender;
        _baseUri = base_Uri_;
    }

    modifier onlyOwner() {
        require(msg.sender == owner, "You are not owner.");
        _;
    }

    function questionURI(uint256 vote_) internal view returns(string memory) {
        return string(abi.encodePacked(_baseUri, _votes[vote_].selection.toString()));
    }

    function setBaseURI(string memory base_Uri_) external onlyOwner {
        _baseUri = base_Uri_;
    }

    function getQuestion() public view returns(string memory) {
        return _votes[totalVote].question;
    }

    function vote(uint256 selection) public {
        require(block.timestamp > _votes[totalVote].startTime &&
            block.timestamp < _votes[totalVote].endTime);
        require(selection <= _votes[totalVote].selection && selection > 0);
        require(_votes[totalVote].voter[msg.sender] == 0);
        _votes[totalVote].voter[msg.sender] = selection;
    }

    function setVote(
        uint256 startTime,
        uint256 endTime,
        uint256 selection,
        string memory question)
        public
        onlyOwner {
        totalVote++;
        _votes[totalVote].startTime = startTime;
        _votes[totalVote].endTime = endTime;
        _votes[totalVote].selection = selection;
        _votes[totalVote].question = question;
    }
}
```

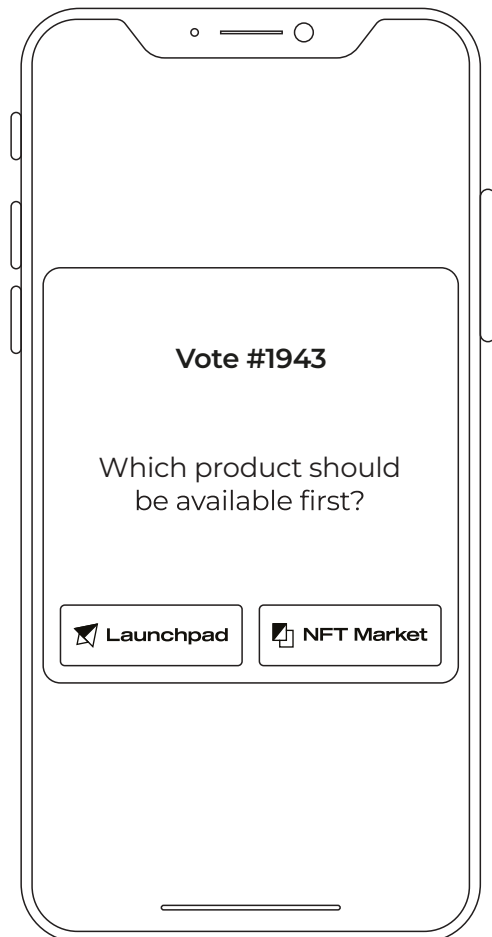

Each MicroMiner is positioned as a mobile node. These mobile nodes allow the user to take part in the system. In this regard, users who know and understand MetaChain and make social contributions to its vision are kept together and in constant communication.

All technologies and products developed are based on human behavior and usage areas. As a result of the research, it has been determined that the success rate of the projects with a strong product-human relationship increases and provides positive results in terms of user satisfaction.

Based on these researches and Metatime culture, the MicroMiner system undertakes the task of providing social interaction as well as managing the Metatime ecosystem by users.

Improvements to MetaChain and other parts of the ecosystem are driven by the votes of MicroMiners.

The only thing that the user who wants to be a MicroMiner has to do is to download the Metatime mobile application and activate the MicroMiner feature from the relevant panel.

For each hour that Metatime application is kept open on a MicroMiner's mobile device, the amount of MTC reflected in their balance is calculated according to the following formula:

$$\frac{30.000}{24 \times TM}$$

(TM: Total MicroMiner)

If the necessary condition is met, MicroMiner transfers the MTC rewards reflected in their balance to their wallet every day at 00:00 (UTC) and they can withdraw it if desired. A MicroMiner can earn a maximum of 100 MTC within a 24-hour period.

In addition to the MTC reward that can be earned from the 30,000 MTC reward pool that is renewed daily at 00:00 (UTC), MicroMiner is also given an MTC reward for answering survey questions received from the Metatime application. The MTC reward that can be earned for answering survey questions is transferred to MicroMiner's wallet at 00:00 (UTC) and can be withdrawn if desired. MicroMiner earns 1 MA for each different survey question answered during the day. At 00:00 (UTC), MicroMiner receives the survey answer rewards from a mining pool of 270,000 MTC, which is proportional to their MA balance and the number of hours they were active during the day.

$$\frac{270.000}{TMA \times \frac{TA}{TM \times 24}} \times MA \times \frac{A}{24}$$

(MA: Points earned for the number of survey questions answered)

(TMA: Total points earned in the pool)

(TM: Total MicroMiner)

(TA: Total active hours of all MicroMiners on the reward day)

(A= Number of active hours during the day)

(TMA ≡ 1)

| Scalability

700.000+ transactions instantly thanks to the artificial intelligence supported MetaAnthill technology

6. Scalability

Metatime instantly verifies millions of transactions thanks to its hybrid mining system and the artificial intelligence supported MetaAnthill technology that manages these systems.

Designed by focusing on the benefits of hardware and technology without relying on a single consensus mechanism, this system solves the scalability issue for developers and users through PoM consensus.

In addition, TCPS (Transaction Check Per Second) 700.000+ can be offered, with the prevention of speed problems due to the scalability problem.

In other words, "Signature Verification" is made instantaneously for each transaction and the transaction is immediately VERIFIED or DENIED.

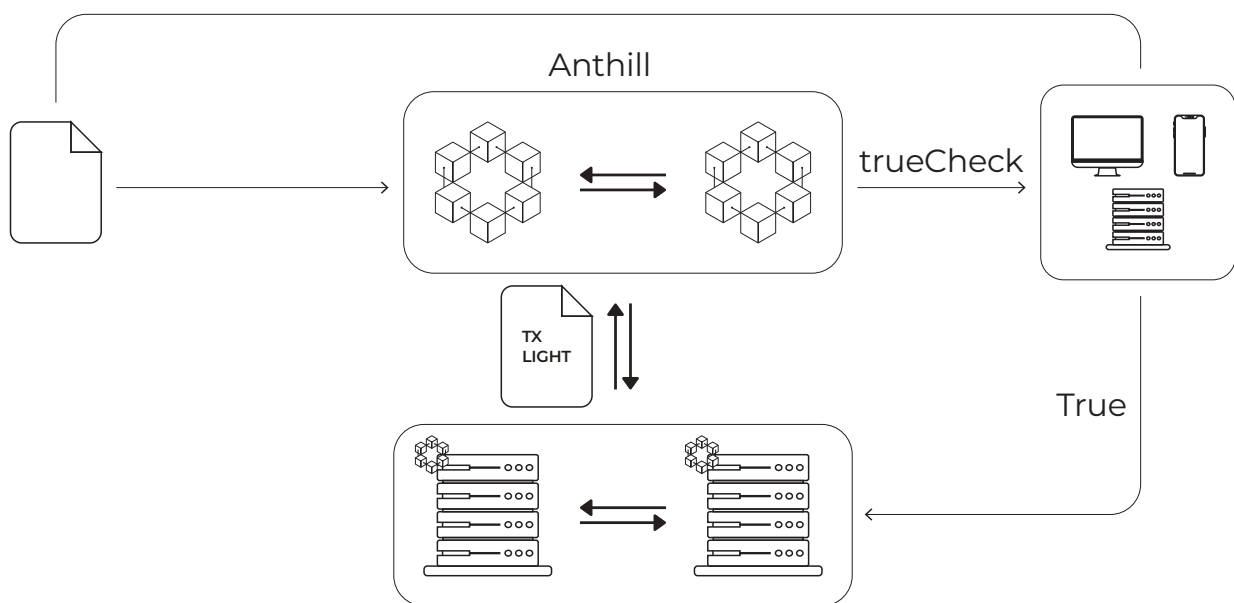

6.1. Blockchain Network Structure

Nodes, which are the most important stakeholders of decentralization in blockchain systems, are supported and encouraged by the easy-to-install hybrid mining system offered. This feature of MetaChain allows its distributed structure to grow at the fastest rate.

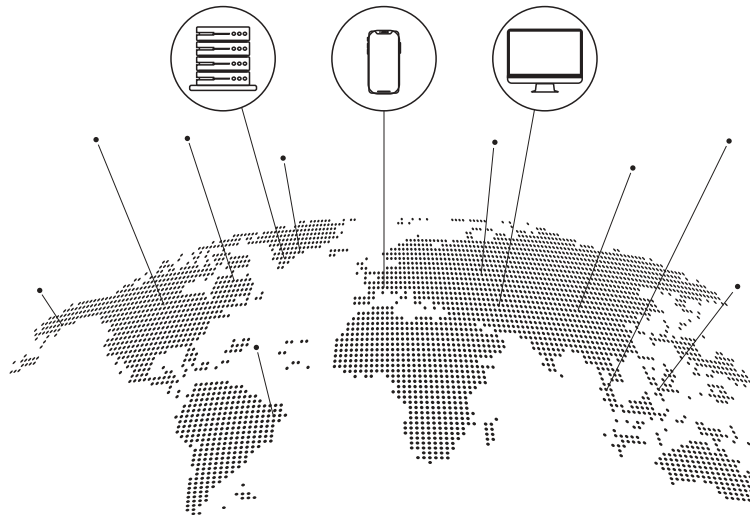

The MetaChain network has been operational since the first day with 19 MetaMiner nodes in different locations in 3 continents of the world. These fixed master nodes are provided by Metatime and their number can reach hundreds of thousands without any problems as infrastructure.

In large-scale studies, not only a blockchain has been developed, but also improvements have been made that will increase the performance of the chain in all aspects, reduce network delays and exceed the limits of existing TCP protocols. Thus, it is guaranteed that the synchronization time between MetaMiner and nodes is always instantly by using the world's most advanced technologies in this field.

6.2. Energy Consumption

The electricity consumption is similar to PoS systems, as miners do not have to resolve any hashes unlike in PoW. Setting out with a human-centered vision, MetaChain advances with a constructive approach wherever people interact, by identifying the problems experienced by other blockchain projects in advance. Besides the nature-friendly side of our project, it adopts the approach of less energy and more efficiency through accurate and innovative technologies at every point of the efforts to reduce the carbon footprint.



| Smart Contract

Maximum compatibility in MetaChain

7. Smart Contract

Smart contracts are scripts consisting of code blocks. A smart contract is a transaction protocol designed to execute, control or document relevant events and actions according to the terms of a contract or agreement. The user who wants to publish a smart contract on MetaChain can transfer the contract in a standard way by linking MetaChain and the wallet in accordance with the information provided in the table below:

Network Information		
Name of The Network	ID of The Chain	Symbol of Native Token
Eleanor Testnet	1967	MTC
Network URL Address	Block Explorer URL Address	
https://rpc.metatime.com/eleanor	https://explorer.metatime.com/eleanor	
Web Socket URL Address		
wss://ws.metatime.com/eleanor		

7.1. Smart Contract Compatibility

MetaChain offers smart contract support in accord with EVM, with the vision of supporting distributed applications and software developers beyond just financial transactions and data storage. Thus, existing smart contracts on Ethereum and similar networks can be uploaded to MetaChain without the need for any modifications.

In addition, Metatime offers the possibility to create Advanced Smart Contracts (MASC / Metatime Advanced Smart Contract); ERC20, ERC721, ERC 1155 and other standardized protocols (See; <https://eips.ethereum.org/all>) and all their associated functions with the help of an interface. Thus, without the need for technical knowledge, a smart contract can be created and uploaded to the chain by drag-and-drop.

Because it is EVM compatible, it allows the use of libraries and tools that are common in the Solidity software language and existing wallet structures.

7.2. Smart Contract Fees

```
pragma solidity ^0.8.0;
```

```
contract HelloWorld {
    function helloWorld() public view returns(string memory) {
        return("Hello World!");
    }
}
```

$$\delta = (\vartheta + 21.000) \times \xi$$

* Smart Contract Fee = δ

* Gas Price = ξ

* $\xi = 130$

Name	Value	Description
δ_{zero}	0	Nothing paid for operations of the set. W_{zero} .
δ_{jumpdest}	1	Amount of gas to pay for a JUMPDEST operation.
δ_{base}	2	Amount of gas to pay for operations of the set W_{base} .
δ_{verylow}	3	Amount of gas to pay for operations of the set W_{verylow} .
δ_{low}	5	Amount of gas to pay for operations of the set W_{low} .
δ_{mid}	8	Amount of gas to pay for operations of the set W_{mid} .
δ_{high}	10	Amount of gas to pay for operations of the set W_{high} .
$\delta_{\text{warmaccess}}$	100	Cost of a warm account or storage access.
$\delta_{\text{accesslistaddress}}$	2400	Cost of warming up an account with the access list.
$\delta_{\text{accessliststorage}}$	1900	Cost of warming up a storage with the access list.
$\delta_{\text{coldaccountaccess}}$	2600	Cost of a cold account access.
$\delta_{\text{coldstorage}}$	2100	Cost of a cold storage access.
δ_{sset}	20000	Paid for an SSTORE operation when the storage value is set to non-zero from zero.
δ_{sreset}	2900	Paid for an SSTORE operation when the storage value's zeroness remains unchanged or is set to zero.
δ_{sclear}	15000	Refund given (added into refund counter) when the storage value is set to zero from non-zero.
$\delta_{\text{selfdestruct}}$	24000	Refund given (added into refund counter) for self-destructing an account.
$\delta_{\text{selfdestruct}}$	5000	Amount of gas to pay for a SELFDESTRUCT operation.
δ_{create}	32000	Paid for a CREATE operation.
$\delta_{\text{codedeposit}}$	200	Paid per byte for a CREATE operation to succeed in placing code into state.
$\delta_{\text{callvalue}}$	9000	Paid for a non-zero value transfer as part of the CALL operation.
$\delta_{\text{callstipend}}$	2300	A stipend for the called contract subtracted from Gcallvalue for a non-zero value transfer.
$\delta_{\text{newaccount}}$	25000	Paid for a CALL or SELFDESTRUCT operation which creates an account.
δ_{exp}	10	Partial payment for an EXP operation.
δ_{expbyte}	50	Partial payment when multiplied by the number of bytes in the exponent for the EXP operation.
δ_{memory}	3	Paid for every additional word when expanding memory.
δ_{txcreate}	32000	Paid by all contract-creating transactions after the Homestead transition.
$\delta_{\text{txdatazero}}$	4	Paid for every zero byte of data or code for a transaction.
$\delta_{\text{txdataonzero}}$	16	Paid for every non-zero byte of data or code for a transaction.
$\delta_{\text{transaction}}$	21000	Paid for every transaction.
δ_{log}	375	Partial payment for a LOG operation.
δ_{logdata}	8	Paid for each byte in a LOG operation's data.
δ_{logtopic}	375	Paid for each topic of a LOG operation.
$\delta_{\text{keccak256}}$	30	Paid for each KECCAK256 operation.
$\delta_{\text{keccak256word}}$	6	Paid for each word (rounded up) for input data to a KECCAK256 operation.
δ_{copy}	3	Partial payment for *COPY operations, multiplied by words copied, rounded up.
$\delta_{\text{blockhash}}$	20	Payment for each BLOCKHASH operation.

≡ ϑ

| Transaction

8.1. Transaction Fees

$$\psi = (\vartheta + (21.000 \times Lne)) \times \xi$$

* Transaction Fee = ψ

* Gas Price = ξ * $\xi = 130$

Transaction fees in Meta Virtual Machine are calculated based on opcodes. An example transaction fee calculation is given below:

Stack Name	Gas	Symbol
CALL	45,141	ϑ
STATICCALL	2,300	φ

Hash 0x933a2936746a4... 📄 ❤️
11 minutes 19 seconds ago (November-19-2019 09:23:35 AM +UTC)

Tx Status
Success

Block
17574

From
0xB7c9b4edc3F30E5f...

To
0xB2226f248362bdc...

Overview Internal Txns

Gas Limit	63,952	Confirmation <small>A confirmation is simply the act of your transaction being included in a block on the blockchain.</small>
Gas Used By Transaction	63,952 (100.00%)	
Gas Price	0.000000130 Meta (130 Gwei)	
Txn Fee	0.008313760 Meta (\$0.00)	

Confirmation Number 133809

Hash 0x933a2936746a4... 📄 ❤️
11 minutes 19 seconds ago (November-19-2019 09:23:35 AM +UTC)

Tx Status
Success

Block
17574

From
0xB7c9b4edc3F30E5f...

To
0xB2226f248362bdc...

Overview Internal Txns

Produced 2 Internal Transaction

Type	Trace Address	From	To	Value	Gas Limit
call_0		0xB7c9b4edc3F30E5fd6B...	0xB2226f48362bdc7ecE...	0 MTC	40,652
staticcall_0_1		0xB2226f48362bdc7ecE...	0xB7c9b4edc3F30E5fd6B...	0.1 MTC	2,300

↗ From
↘ To

Attack Vectors & Security

9.1. Transaction Denial

Transaction denial is a type of attack in which the attacker aims to disrupt the functioning of the network structure by creating a density in the network. Attackers trying to asynchronize the network structure via multiple operations in the MetaChain network get hooked on MetaAnthill technology.

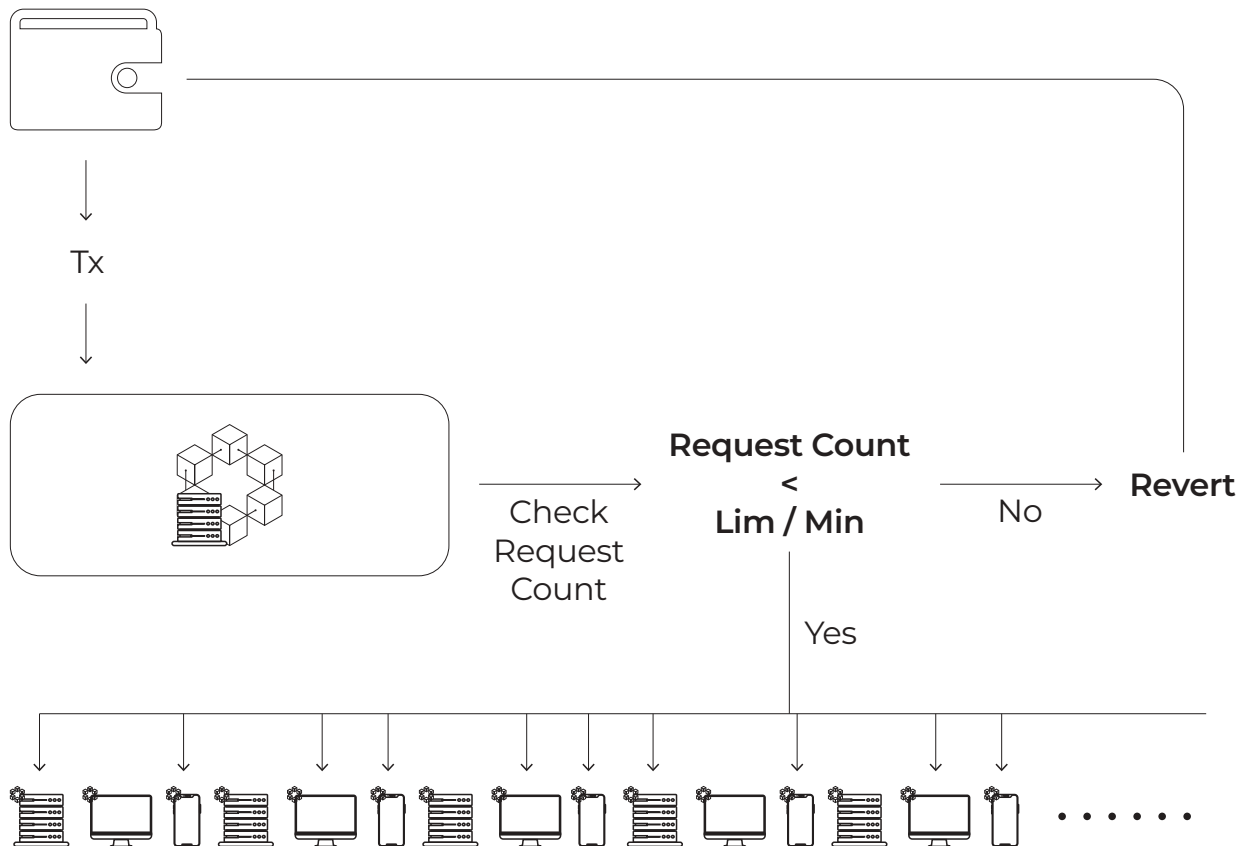

If the transaction requests sent by the same user to the MetaChain network are of an unusual density and format, MetaAnthill directly rejects the requests and prevents them from being forwarded to the nodes. Thus, artificial processing density is prevented from the first step, and the synchronization problem and unnecessary traffic that the attacker attempts to create in the nodes is prevented.

9.2. Eclipse Attack

Eclipse attack is an attack method used in architectures where the network shares the workload with the nodes.

The purpose of this attack is to inactivate a particular node connection by providing more workload than its capacity and to seize the node connections.

For example, if a node has 8 connections and these connections accept up to 128 transactions, the attacker creates an overload on connections by sending more than 128 transactions to the focused node. As this overload will cause problems in the communication of all 8 connections with each other, the attacker takes advantage of the vulnerability of the connections and takes the chain structure view under control.

Thanks to MetaAnthill, any artificial and natural traffic that can be experienced in the MetaChain network is suspended.

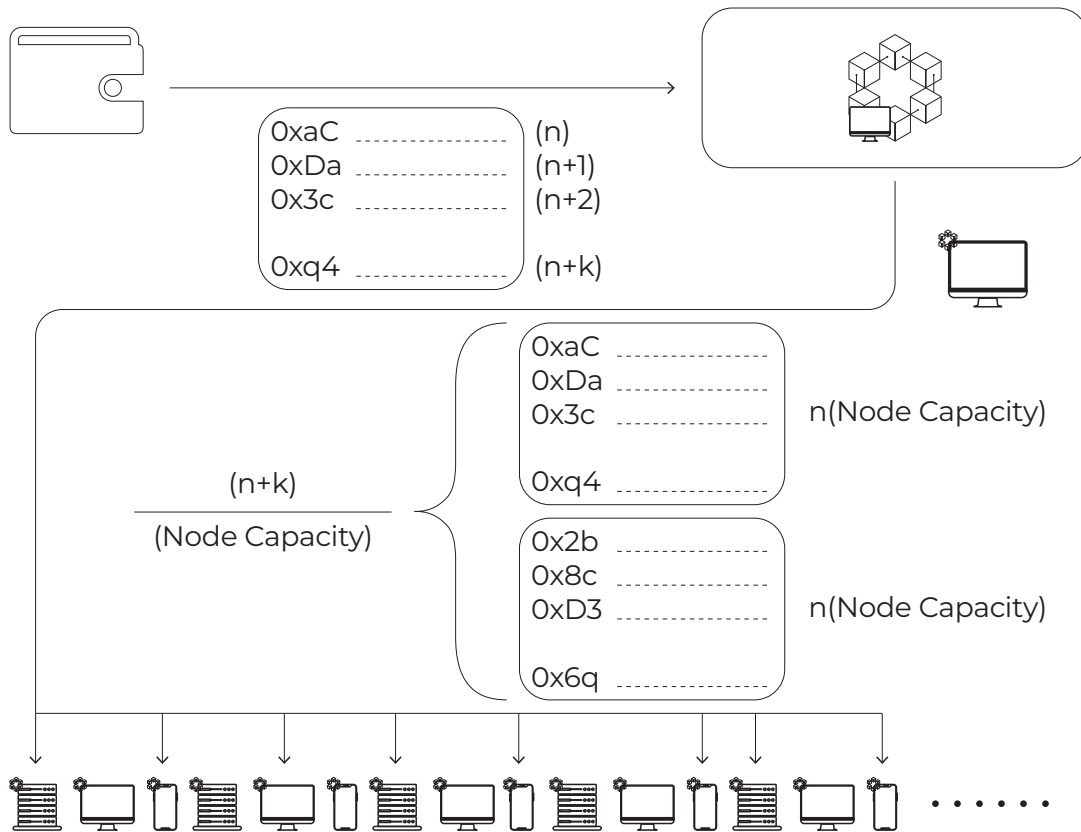

If $(n+k)$ transactions arrive in the network above the node capacity, it suspends $(n+k)$ transactions in packages in the form of $n * (\text{Node Capacity})$, so as not to exceed the node capacity.

Thus, neither the large number of transactions executed by the attacker nor the large number of transactions occurring naturally can cause an overcapacity load on the nodes.

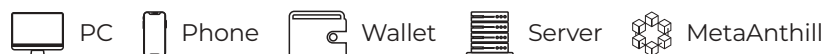

9.3. Double Spending

Double spending is a type of attack that makes the same transaction operation to be performed more than once.

The attacker aims to make multiple expenses by sending the same signed transaction back to the network while the transaction is still in the process of being recorded in blocks.

The same transaction sent more than once by an attacker is subjected to the "Pre-verified Sign Is Valid" stage by MetaAnthill. Unsigned transactions are denied directly, and nodes are prevented from performing the same transaction a second time.

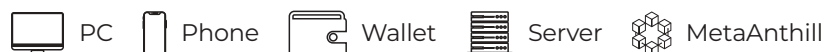
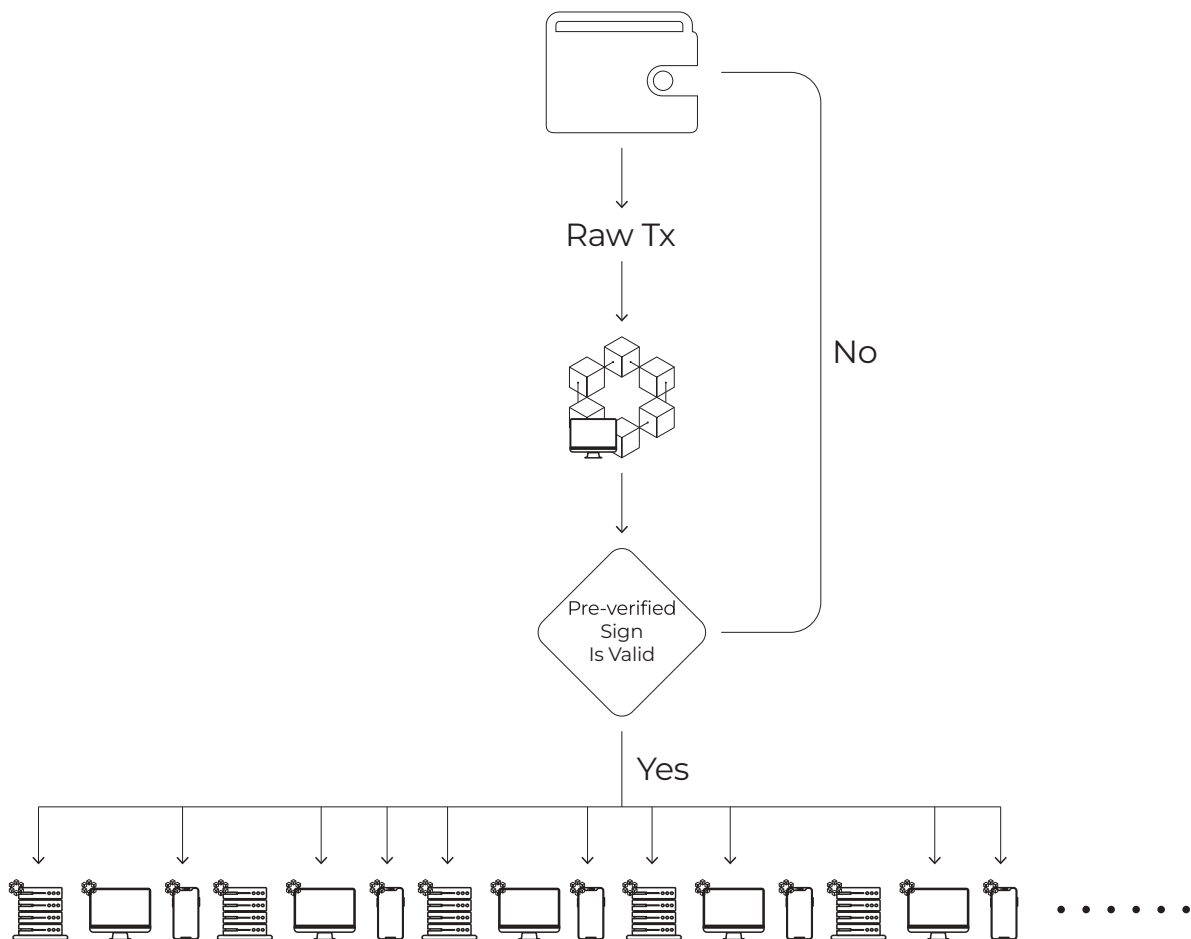

| Native Token

10. Native Token

The most important feature that distinguishes the native token from standard tokens such as ERC-20 is that transactions such as transaction verifications and calculations within a blockchain are performed with the native token, which is the network's own digital asset value. All transactions on MetaChain use native tokens directly.

10.1. MetaCoin (MTC)

MetaCoin (MTC) is the native token of the MetaChain network created with a limited supply of 10 billion units on the MetaChain network.

MTC is designed to be used in the network structure with the capacity of hundreds of thousands of transactions per second on the products developed on the MetaChain network. MetaCoin has been designed with both transfer and fixed burning formulas, by distributing it to certain pools in order to meet the expectations for every need of the users.

Within all these setups, MTC, as the native token of the MetaChain network, is an important intersection of products developed on-chain.

10.2. Token Burning

In the framework of the policy of protecting the value and being sustainable, supply restriction is ensured by burning systems. Two different burning methods are used for MTC.

Thanks to the burning system with continuous supply restriction, transfer burning is applied in all transactions within the network, and a constant burning formula is applied at every time that the network spends on a time basis.

In this way, it is ensured that the circulating token supply is kept in a deflationary structure by preventing a continuous and large increase.

10.2.1. Transaction Fee Burning

Although the MetaChain network is among the most suitable networks for transaction fees, the sum of the transfer transaction fees arising from intra-network mobility will reach quite high amounts, based on the ecosystem value.

In every transaction performed on MetaChain, cost-effective transactions and burning are performed. While the fees paid for the transfers are distributed to the pools determined by the system, as a result of this transaction, the MetaCoins accumulated in the Burn Pool are triggered and burned on a daily basis.

$$BM = (F/10).(T+1)/(2.T^2)$$

Amount of MetaCoins to Burn (BM) (BM)
 Transfer Fee (MTC) (F)
 10 Million Burned MetaCoins (T)
 20 Million Burned MetaCoins (T+1)

All of the transfer fees within the MetaChain network are distributed to certain pools.

The MTCs accumulated in the Fee Pool are shared daily as follows.

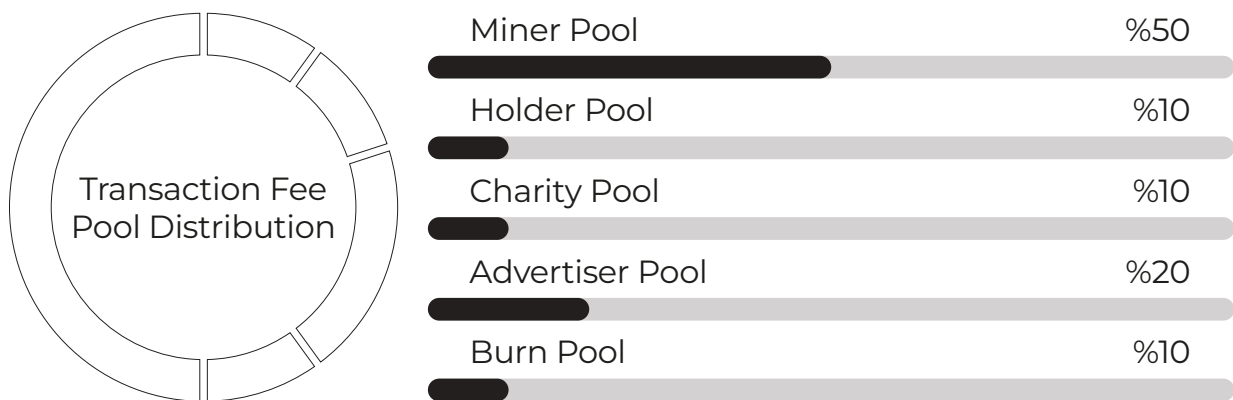

- Miner Pool** | Represents the MTC allocated for each transfer result for high-yield mining models.
- Holder Pool** | Represents MTC, which is reserved for investors to develop their earnings patterns.
- Charity Pool** | Collects funds for charities from each transaction made on its blockchain network MetaChain, Charity Pool represents the MTC allocated for these charities.
- Advertiser Pool** | Represents MTC allocated for promotion and advertising budget.
- Burn Pool** | Represents the MTC to be burned after each transfer for sustained supply restriction. It is completely burned and removed from circulation.

10.2.2. Constant Burning

While investors and Metatime users are financially protected thanks to the unstoppable continuation of the supply restriction by MetaChain and the indefinitely **constant burning mechanism** that continues in high amounts at the beginning and then decreases, MTC gains value in terms of supply-demand balance day by day. For all MetaCoins that are not sold during the presale phase, a burn pool is created and transferred to this pool. The MetaCoins transferred to the burn pool are burned through the Auto-Burn mechanism.

Auto-Burn is a formula that guarantees to remove the maximum MTC from the circulation in the optimum time without leaving the burning process to the initiative of the individual.

$$M = ((MB.13.10^4) / (100LP + S)) \cdot ((\text{Cos}(n.10^{-9} + 86)).2,923)$$

Amount of MetaCoins to Burn	(M)
Liquidity Price	(LP)
Number of Blocks Produced in 2 Months	(MB)
Variable Value	(S) (Initial Value: 1000)
Total Burned MetaCoins	(n)

With the Auto-Burn formula, burning is performed regularly in 2-month periods, inversely proportional to the MTC price.

Under the $\text{Cos}90=0$ valuation, the formula remains unchanged until unsold MTCs are burned.

10.3. Pool Distribution

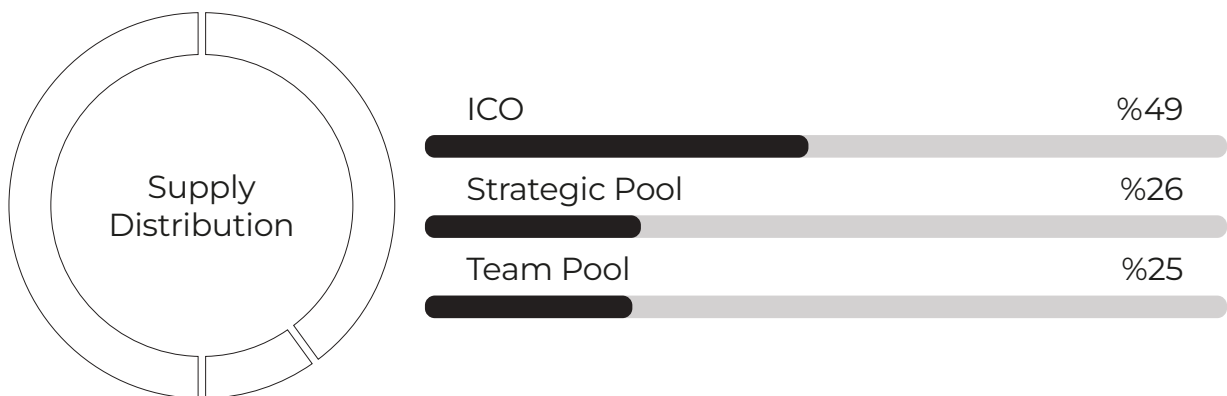

ICO	Represents the amount set aside for the MTC pre-sale.(Any unsold MetaCoins during the presale will be burned through the Auto-Burn mechanism).
Strategic Pool	Represents the sum of MTCs required for Marketing, Miner Reward, Burn, AirDrop , Charity Pool and Liquidity.
Team Pool	Represents the amount of MTC reserved for the Metatime team.

| Experimental Results

| 11. Experimental Results

Benchmarking information and data such as **TCPS**, **MVM**, **MetaAnthill** **provided by MetaChain** can be done by sending transactions to the RPC URL.

The hardware used in the Eleanor testnet, environmental parameters and the resulting data will be shared in a separate document on the website.

| Information

| 12. Information

As the testnet and products continue to be developed, source codes are not yet open source for security purposes. After the mainnet stage, it will be made available to the community as open source. This technical article will be regularly updated in parallel with the development of the system.

| Audit

| 13. Audit

Our in-house security engineers specializing in finance, software and blockchain regularly test the system end-to-end. In addition, a pre-mainnet bug-bounty program will be implemented. Penetration tests and code inspections will be performed by independent audit companies and test reports will be shared.

Penetration tests will be based on 4 main structures:

1. Infrastructure Penetration Testing
2. Smart Contract Security Audit
3. Web Application Penetration Testing
4. Miner Apps Penetration Testing

| Solution and Conclusion

| Solution and Conclusion

Metatime has always focused on developing blockchain technology and integrated it into human life. MetaChain has developed innovative technologies by detecting user needs that existing blockchain networks cannot meet.

These technologies include MetaAnthill, a unique solution, the Hybrid Mining Model to which it is affiliated, and the Proof of Meta consensus mechanism.

MetaAnthill maximizes speed, which is one of the main problems of existing networks, by fully exploiting the potential of the Web 3.0.

The Hybrid Mining System provides maximum security by increasing the blockchain structure to the maximum level of distribution.

Proof of Meta provides optimal decentralization by connecting the solution to the decentralization of the blockchain trilemma with the participation and guidance of all users.

In addition to the solutions produced based on MetaChain, Metatime has also undertaken to develop the main ecosystem applications that may be required on the network. These practices form part of a human-centered, fair and fully integrated ecosystem in nature. Thus, it is aimed to go beyond making blockchain technology available to only a limited and small community, to familiarize wider audiences with the technology and to diversify its usage scenarios. Purposefully, surfaces such as MicroMiner have been created that will engage with the users directly.

With MetaChain, the user profile and needs have been addressed at all levels, from individual to sectoral use, and the network and its unique features have been designed considering both technological and social reflexes.

Bridge feature allows users on both the local network and other networks supported by MetaChain to transfer their assets across chains.

Through its browser extension, MetaChain enables users to transfer their assets on the network and interact with ecosystem projects. Additionally, other networks operating on the infrastructure supported by MetaChain can be added to this wallet. Thus, users can easily manage all their digital assets with a single wallet.

Focused on 'Human'

Not only is the ease of use, security and speed of the created structure important, but also structures have been developed in which users can be included and directed to the system from day one, thanks to structures such as MicroMiner.

At every point of the MetaChain design, the main focus has been to enable users to easily understand and use the products. It has been studied on an understandable user experience for everyone, away from the complexity and difficult-to-explain perception of blockchain technologies.

In addition to encouraging application development by different users, an ecosystem of applications developed directly by the Metatime team; It offers safe, fast, distributed and effective solutions from the daily needs of individual users to the most complex problems of institutions.

With this approach, it has been ensured that basic ecosystem applications are running on the network from the moment the network is made available. In addition, thanks to this approach, human-centered solutions are presented as a quality and approach standard.

To see all the products offered by Metatime, you can visit the Metatime website (<https://metatime.com>)

References

References

Articles

Buterin, Vitalik. "A next-generation smart contract and decentralized application platform." white paper 3.37 (2014): 2-1

Kaygan, Pınar. "UTAK 2014 BİLDİRİ KİTABI: EĞİTİM, ARAŞTIRMA, MESLEK VE SOSYAL SORUMLULUK." 2014.

Liang, Yanxia. "Application of Gestalt psychology in product human-machine Interface design." IOP Conference Series: Materials Science and Engineering. Vol. 392. No. 6. IOP Publishing, 2018.

Orogun, Adebola Okunola. "Brief insight into transmission control protocol (TCP)." 2017.

Timmer, Mark, P-T. de Boer, and Aiko Pras. "How to identify the speed limiting factor of a tcp flow." 2006 4th IEEE/IFIP Workshop on End-to-End Monitoring Techniques and Services. IEEE, 2006.

Wood, Gavin. "Ethereum: A secure decentralised generalised transaction ledger." Ethereum project yellow paper 151.2014 (2014): 1-32.

Websites



<https://github.com/metatimeofficial>

<https://eips.ethereum.org/all>

<https://vitalik.ca/general/2017/12/17/voting.html>

As a result of years of research and development, we have built a blockchain-based ecosystem where all needs can be met through a single decentralized platform.

Metatime ecosystem, which is based on decentralization in all its products, has a single focus: 'Human'.

| Disclaimer

Disclaimer

Please read this Disclaimer and the entire Whitepaper carefully. Do not invest in the private sale of MetaChain native tokens or purchase MetaCoins without doing so.

The founders do not warrant or assume any legal liability arising out of or in connection with the accuracy, reliability or completeness of any material contained in or relating to this Whitepaper or presented elsewhere. To the fullest extent permitted by applicable laws, regulations and rules, Metatime does not warrant or assume any legal liability of any kind, whether indirect, special, incidental, consequential, punitive, or otherwise, whether in contract or otherwise, for any loss of profits, revenue, income, or other loss (including, but not limited to loss of use or data) arising out of or in connection with the accuracy, reliability, relevance or completeness of any material contained in the Whitepaper.

Metatime does not make, or intend to make, and hereby disclaims and negates all representations, warranties or undertakings of any kind to any entity, person or authority, including any representations, warranties or undertakings as to the truthfulness, accuracy or completeness of any information contained in the Whitepaper.

Although Metatime will use its best efforts to ensure the accuracy, timeliness and relevance of any material contained in the Whitepaper, the document and the material contained therein do not constitute professional advice.

Metatime does not encourage you to purchase MetaCoin. We are simply outlining our plans for our system, and we offer anyone who shares and understands our vision and wants to be part of MetaCoin.

You should not purchase tokens if you are a citizen or resident (tax or otherwise) of a country or territory where transactions in digital tokens and/or digital currencies are prohibited or otherwise restricted by applicable law.

Purchasing MetaCoin involves an element of risk and may result in the loss of a significant portion or all of the principal amount invested. Before purchasing MetaCoin, you should carefully and thoroughly assess and consider the risks identified in this Whitepaper and other risks not covered or foreseen in this document. You should only purchase MetaCoin if you are fully aware of the tokenomics of MetaCoin supply and issuance and the economics of MetaCoin. The value of cryptocurrencies can decrease as well as increase in value, so take this into account before buying MetaCoin. The price of MetaCoin is affected by many factors over which MetaTime has no control. Consequently, Metatime does not assume any liability for losses resulting from changes in the value of MetaCoin.

Cryptoassets may be subject to expropriation and/or theft. Computer hackers or other malicious groups or entities may attempt to disrupt the MetaChain platform in a number of different ways - these may include malicious attacks, distributed denial of service attacks and consensus-based exploits such as the 51% attack, which can result in the loss of MetaCoin or the loss of the ability to access MetaCoin. Due to the immutable nature of blockchain transactions, it may not be possible to remediate in the event of a successful attack by malicious actors against the MetaChain platform. Metatime will take all possible steps to prevent cyber-attacks on the system, but will not be liable for or refund any amounts resulting from attacks on the system.

Cryptoassets may not be regulated as a financial instrument and there may not be any reimbursement or compensation available from regulators in your jurisdiction. The regulatory status of cryptoassets remains in flux and varies from jurisdiction to jurisdiction, creating a degree of legal uncertainty for cryptoasset owners. It is possible that in the future certain laws, regulations, directives or rules relating to cryptoassets, blockchain technology or decentralized applications may be enacted that affect or restrict the ability of token holders to acquire, own and use cryptoassets, such as MetaCoin.

Due to the uncertainties surrounding the tax laws relating to cryptoassets, token holders may be subject to unforeseen consequences, such as retroactive or future taxable events. All prospective MetaCoin purchasers should consider their own individual risk appetite and should consider consulting an independent financial advisor before making any decisions. Readers of this Whitepaper may also need to consult a tax advisor, accountant, lawyer or other professional to fully ascertain any outstanding issues relating to the design and operation of the MetaChain platform before deciding whether the purchase of MetaCoin is appropriate for their risk profile. In view of the unregulated nature of the taxation of crypto assets, Metatime does not assume any tax liability in connection with MetaCoin purchases, transactions and other operations. This Whitepaper has been prepared in Turkish and English, and if there is a difference between the two versions, the Turkish version will be taken as the basis.

 **MetaChain**

Powered by Metatime